

## Overview



SITRANS LR200 is a 2-wire, 6 GHz pulse radar level transmitter for continuous monitoring of liquids and slurries in process vessels including high temperature, pressure, agitation, and turbulence to a range of 20 m (65 ft).

## Benefits

- Graphical local user interface (LUI) makes operation simple with plug-and-play setup using the intuitive Quick Start Wizard
- LUI displays echo profiles for diagnostic support
- Communication using HART or PROFIBUS PA
- Process Intelligence signal processing for improved measurement reliability and Auto False-Echo Suppression of fixed obstructions
- Programming using infrared Intrinsically Safe handheld programmer or SIMATIC PDM

## Application

SITRANS LR200's unique design allows safe and simple programming using the Intrinsically Safe handheld programmer without having to open the instrument's lid. It also features a built-in alphanumeric display in four languages.

The SITRANS LR200 has a standard Uni-Construction polypropylene rod antenna that offers excellent chemical resistance and is hermetically sealed. The Uni-Construction antenna features an internal, integrated shield that eliminates vessel nozzle interference.

Startup is easy with as few as two parameters for basic operation. Installation is simplified as the electronics are mounted on a rotating head that swivels, allowing the instrument to line up with conduit or wiring connections or simply to adjust the position for easy viewing. SITRANS LR200 features Process Intelligence signal-processing technology for superior reliability.

- Key Applications: liquid process vessels with agitators, vaporous liquids, high temperatures, asphalt

## SITRANS LR200

## Integration

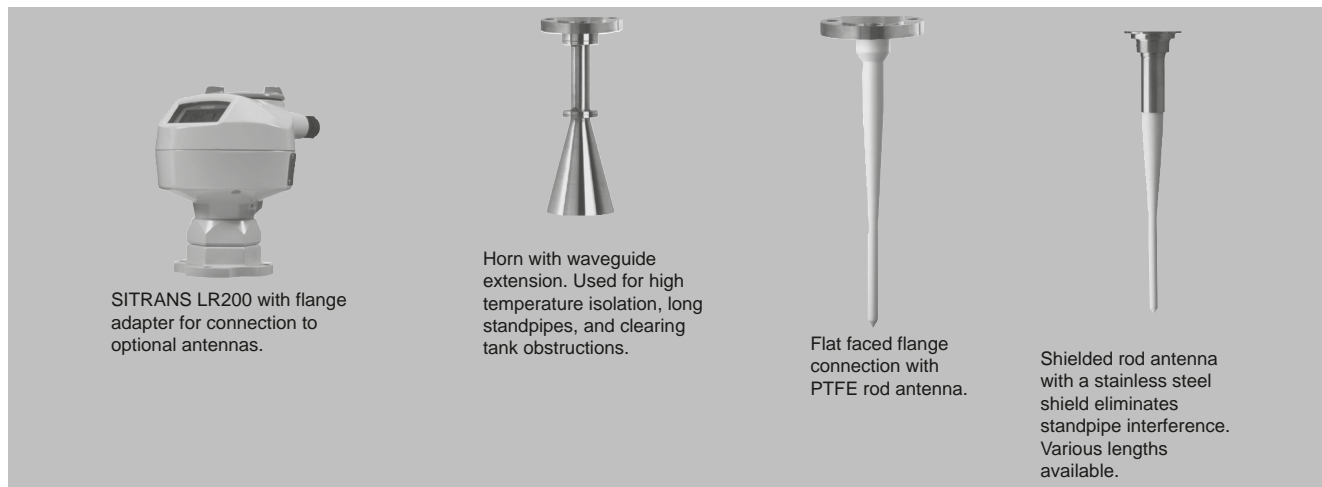

Antenna configurations for SITRANS LR200

Antenna types	Flat Faced Flange with Rod	Shielded Rod	Horn (4", 6", 8" sizes available)
Connection type	Flat faced flange nominal pipe sizes 50, 80, 100, 150 mm (2, 3, 4, 6 inch)	Threaded 2" NPT, R 2" (BSPT), G 2" (BSPP) or flat faced flange nominal pipe sizes 80, 100 mm (3, 4 inch)	Flat faced flange nominal pipe sizes 50, 80, 100, 150 mm (2, 3, 4, 6 inch)
Wetted parts	PTFE	PTFE, 316L stainless steel, FKM O-ring	316L stainless steel PTFE, FKM O-ring
Extensions	50 or 100 mm (2 or 4 inch) PTFE or UHMW-PE	100, 150, 200 or 250 mm (4, 6, 8 or 10 inch) standard shield length	Use waveguide for extensions to 6 m (20 ft) long
Dielectric constant	> 3	> 3	> 3
Insertion length (max.)	41 cm (16.3 inch)	Variable	Variable with extension
Purging option (liquid or gas)	No	No	Yes
Sliding waveguide option for digesters <sup>1)</sup>	Yes	No	Yes
Weight <sup>2)</sup>	6.5 kg (14.3 lb)	5.0 kg (11 lb)	7.5 kg (16.5 lb)

<sup>1)</sup> Maximum pressure 0.5 bar g at 60 °C (7.25 psi g at 140 °F)

<sup>2)</sup> Not including extensions, includes SITRANS LR200 and smallest process connection

## Configuration

### Installation

#### Note:

- Beam angle is the width of the cone where the energy density is half of the peak energy density.
- Beam angle for horn antenna dependent on horn size
- The peak energy density is directly in front of and in line with the rod antenna.
- There is a signal transmitted outside of the beam angle; therefore false targets may be detected.

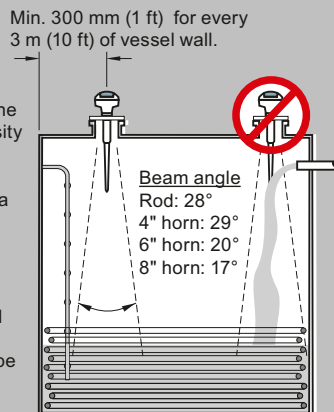

### Mounting unit on vessel

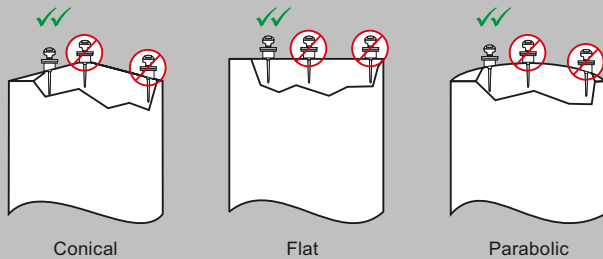

### Mounting unit on stilling well

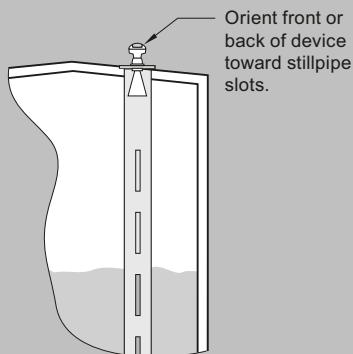

### Mounting on a nozzle

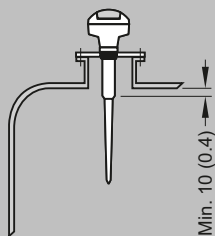

SITRANS LR200 installation, dimensions in mm (inch)

## SITRANS LR200

## Selection and ordering data

	Article No.					
<b>SITRANS LR200 Radar level transmitter with polypropylene rod</b> <b>Continuous, non-contact, 20 m (66 ft) range, for liquids and</b> <b>slurries.</b>	7ML5422-	●	●	●	●	0
Click on the Article No. for the online configuration in the PIA Life Cycle Portal.						
<b>Enclosure/Cable inlet</b>						
Aluminum, epoxy painted						
2 x 1/2" NPT		2				
2 x M20 x 1.5		3				
<b>Polypropylene antenna type - (Max. 3 Bar pressure and 80 °C)</b>						
1 1/2" NPT [(Taper), ASME B1.20.1], c/w integral 100 mm shield				A		
R 1 1/2" [(BSPT), EN 10226], c/w integral 100 mm shield				B		
G 1 1/2" [(BSPP), EN ISO 228-1], c/w integral 100 mm shield				C		
1 1/2" NPT [(Taper), ASME B1.20.1], c/w integral 250 mm shield				D		
R 1 1/2" [(BSPT), EN 10226], c/w integral 250 mm shield				E		
G 1 1/2" [(BSPP), EN ISO 228-1], c/w integral 250 mm shield				F		
<b>Approvals</b>						
Ordinary Locations/General Purpose (Non-Ex), CE, UKCA, RED, RCM					A	
General Purpose, CSA, FM, Industry Canada, FCC Ordinary Locations/General Purpose (Non-Ex), CSA, FM, IC, FCC					B	
Intrinsically Safe, CSA Class I, II, Div. 1, Groups A, B, C, D, E, F, G, Industry Canada					C	
Intrinsically Safe, FM Class I, II, Div. 1, Groups A, B, C, D, E, F, G, FCC					D	
Intrinsically Safe; ATEX II 1G Ex ia IIC T4 Ga; UKEX II 1G Ex ia IIC T4 Ga; IECEX Ex ia IIC T4 Ga; INMETRO Ex ia IIC T4 Ga, IP67/IP68; EAC Ex 0Ex ia IIC T4 Ga X; CE, UKCA, RED, RCM, EAC					E	
Non incandive, FM Class I, Div. 2, Groups A, B, C, D, FCC <sup>1)</sup>					F	
Increased Safety; ATEX II 1/2G Ex eb mb ia IIC T4 Ga/Gb; UKEX II 1/2G Ex eb mb ia IIC T4 Ga/Gb; CE, UKCA, RED, RCM, EAC <sup>2)3)</sup>					G	
Flameproof: ATEX II 1/2G Ex db mb ia IIC T4 Ga/Gb; UKEX II 1/2G Ex db mb ia IIC T4 Ga/Gb; CE, UKCA, RED, RCM, EAC <sup>3)</sup>					H	
Explosion Proof, CSA/FM Class I, II, III, Groups A, B, C, D, E, F, G, Industry Canada, FCC <sup>1)3)</sup>					J	
<b>Communication/Output</b>						
PROFIBUS PA					2	
4 ... 20 mA, HART, start-up at < 3.6 mA					3	

1) Available with enclosure option 2 only.

2) Available with enclosure option 3 only.

3) Available with communication option 3 only.

Selection and Ordering data	Order code
<b>Further designs</b>	
Please add "-Z" to Article No. and specify Order code(s).	
Stainless steel tag [69 x 50 mm (2.71 x 1.97 inch)]: Measuring-point number/identification (max. 27 characters); specify in plain text	<b>Y15</b>
Manufacturer's test certificate: M to DIN 55350, Part 18 and to ISO 9000	<b>C11</b>
Namur NE43 compliant, device preset to failsafe < 3.6 mA <sup>1)</sup>	<b>N07</b>

Accessories	Article No.
<b>Operating Instructions</b>	
All literature is available to download for free, in a range of languages, at <a href="http://www.siemens.com/processinstrumentation/documentation">http://www.siemens.com/processinstrumentation/documentation</a>	
<b>Accessories</b>	<b>Article No.</b>
Handheld programmer, Intrinsically safe, EEx ia	<b>7ML1930-1BK</b>
HART modem with USB interface	<b>7MF4997-1DB</b>
One metallic cable gland M20 x 1.5, rated -40 ... +80 °C (-40 ... +176 °F), HART <sup>2)</sup>	<b>7ML1930-1AP</b>
One metallic cable gland M20 x 1.5, rated -40 ... +80 °C (-40 ... +176 °F), PROFIBUS PA <sup>2)</sup>	<b>7ML1930-1AQ</b>
One general purpose polymeric cable gland M20 x 1.5, rated -20 ... +80 °C (-40 ... +176 °F)	<b>7ML1930-1AM</b>

## Selection and ordering data (continued)

Accessories	Article No.
SITRANS RD100, loop powered display - see Chapter 7	7ML5741-.....-
SITRANS RD150, remote digital display for 4 ... 20 mA and HART devices - see Chapter 7	7ML5742-.....-
SITRANS RD200, universal input display with Modbus conversion - see Chapter 7	7ML5740-.....-

Accessories	Article No.
SITRANS RD300, dual line display with totalizer and linearization curve and Modbus conversion - see Chapter 7	7ML5744-.....-
For applicable back up point level switch - see point level measurement section	

- 1) Available with communication option 3 only.  
 2) Product shipped with plastic cable gland, rated to -20 °C. If -40 °C rating required, then metallic cable gland is recommended.

SITRANS LR200 Radar level transmitter with PTFE rod Continuous, non-contact, 20 m (66 ft) range, for liquids and slurries.		Article No.										
		7ML5423-	●	●	●	●	●	-	●	●	●	●
Click on the Article No. for the online configuration in the PIA Life Cycle Portal.												
<b>Antenna material (uses antenna adapter)</b>												
PTFE, uses antenna adapter and additional process connection below		1										
<b>Process connection (refer to LR200 Pressure/Temperature curves)</b>												
Flanges (316L stainless steel)												
DN 50 PN 16, Type A, flat faced		A		A								
DN 80 PN 16, Type A, flat faced		B		A								
DN 100 PN 16, Type A, flat faced		C		A								
DN 150 PN 16, Type A, flat faced		D		A								
2" ASME 150 lb, flat faced		F		B								
3" ASME 150 lb, flat faced		G		B								
4" ASME 150 lb, flat faced		H		B								
6" ASME 150 lb, flat faced		J		B								
DN 50 PN 40, flat faced		A		C								
DN 80 PN 40, flat faced		B		C								
DN 100 PN 40, flat faced		C		C								
DN 150 PN 40, flat faced		D		C								
2" ASME 300 lb, flat faced, available with Pressure rating option 1 only due to flange hole spacing		F		D								
3" ASME 300 lb, flat faced		G		D								
4" ASME 300 lb, flat faced		H		D								
6" ASME 300 lb, flat faced		J		D								
JIS DN 50 10K		A		E								
JIS DN 80 10K		B		E								
JIS DN 100 10K		C		E								
JIS DN 150 10K		D		E								
(Note: Flange bolting patterns and facings dimensionally correspond to the applicable ASME B16.5, or EN 1092-1, or JIS B 2220 standard.)												
Threaded connection (316L stainless steel)												
1½" NPT [(Taper), ASME B1.20.1]		L		A								
2" NPT [(Taper), ASME B1.20.1]		M		A								
R 1½" [(BSPT), EN 10226]		L		C								
R 2" [(BSPT), EN 10226]		M		C								
G 1½" [(BSPP), EN ISO 228-1]		L		E								
G 2" [(BSPP), EN ISO 228-1]		M		E								
<b>Antenna extensions or Inactive shield length</b>												
No antenna extension						0						
50 mm (2 inch) extension, PTFE						1						
100 mm (4 inch) extension, PTFE						2						
100 mm (4 inch) extension, 316L stainless steel shield <sup>1)</sup>						3						
150 mm (6 inch) extension, 316L stainless steel shield <sup>1)</sup>						4						
200 mm (8 inch) extension, 316L stainless steel shield <sup>1)</sup>						5						
250 mm (10 inch) extension, 316L stainless steel shield <sup>1)</sup>						6						
<b>Process seal/gasket</b>												
Integral Gasket, for flat faced flange process connections only, not for Antenna extension options 3 ... 6						0						
FKM O-ring, not available for combination of flat faced flanges with Antenna extension options 0, 1 or 2						1						

## SITRANS LR200

## Selection and ordering data (continued)

	Article No.										
<b>SITRANS LR200 Radar level transmitter with PTFE rod</b> Continuous, non-contact, 20 m (66 ft) range, for liquids and slurries.	7	M	L	5	4	2	3	-	•	•	•
<b>Enclosure/Cable inlet</b> Aluminum, Epoxy painted 2 x ½" NPT 2 x M20 x 1.5										2 3	
<b>Communication/Output</b> PROFIBUS PA 4 ... 20 mA, HART, start-up at < 3.6 mA											B C
<b>Approvals</b> Ordinary Locations/General Purpose (Non-Ex), CE, UKCA, RED, RCM General Purpose, CSA Ordinary Locations/General Purpose (Non-Ex), CSA, FM, IC, FCC Intrinsically Safe, CSA Class I, II, Div. 1, Groups A, B, C, D, E, F, G, Industry Canada Intrinsically Safe, FM Class I, II, Div. 1, Groups A, B, C, D, E, F, G, FCC Intrinsically Safe; ATEX II 1G Ex ia IIC T4 Ga; UKEX II 1G Ex ia IIC T4 Ga; IECEX Ex ia IIC T4 Ga; INMETRO Ex ia IIC T4 Ga, IP67/IP68; EAC Ex 0Ex ia IIC T4 Ga X; CE, UKCA, RED, RCM, EAC Non incandive, FM Class I, Div. 2, Groups A, B, C, D, FCC <sup>2)</sup> Increased Safety: ATEX II 1/2G Ex eb mb ia IIC T4 Ga/Gb; UKEX II 1/2G Ex eb mb ia IIC T4 Ga/Gb; CE, UKCA, RED, RCM, EAC <sup>2)3)</sup> Flameproof: ATEX II 1/2G Ex db mb ia IIC T4 Ga/Gb; UKEX II 1/2G Ex db mb ia IIC T4 Ga/Gb; CE, UKCA, RED, RCM, EAC <sup>3)</sup> Explosion Proof, CSA/FM Class I, II, III, Groups A, B, C, D, E, F, G, Industry Canada, FCC <sup>2)4)</sup>											A B C D E  F G  H  J
<b>Pressure rating</b> Rating per Pressure/Temperature curves in manual 0.5 bar g (7.25 psi g) maximum											0 1

1) Available with process connection options BA, CA, DA, GB, HB, JB, BC, CC, DC, GD, HD, JD, BE, CE, DE, MA, MC, ME only.

2) Available with enclosure option 2 only.

3) Available with enclosure option 3 only.

4) Available with communication option C only.

Selection and Ordering data	Order code
<b>Further designs</b> Please add "-Z" to Article No. and specify Order code(s).	
Stainless steel tag [69 x 50 mm (2.71 x 1.97 inch)]: Measuring-point number/identification (max. 27 characters); specify in plain text	Y15
Manufacturer's test certificate: M to DIN 55350, Part 18 and to ISO 9000	C11
Material inspection Certificate Type 3.1 per EN 10204	C12
Namur NE43 compliant, device preset to failsafe < 3.6 mA <sup>3)</sup>	N07

Accessories	Article No.
<b>Operating Instructions</b> All literature is available to download for free, in a range of languages, at <a href="http://www.siemens.com/processinstrumentation/documentation">http://www.siemens.com/processinstrumentation/documentation</a>	
<b>Accessories</b> Handheld programmer, Intrinsically safe, EEx ia Antenna, rod, PTFE	7ML1930-1BK 7ML1830-1HC

Accessories	Article No.
Antenna extension, 50 mm (2 inch), PTFE	7ML1830-1CH
Antenna extension, 100 mm (4 inch), PTFE	7ML1830-1CG
HART modem with USB interface	7MF4997-1DB
Metallic cable gland M20 x 1.5, rated -40 °C (-40 °F) ... 80 °C (176 °F), HART (two are required)	7ML1930-1AP
Metallic cable gland M20 x 1.5, rated -40 °C (-40 °F) ... 80 °C (176 °F), PROFIBUS PA (two required)	7ML1930-1AQ
One General Purpose polymeric cable gland M20 x 1.5, rating for -20 °C (-4 °F) ... + 80 °C (176 °F)	7ML1930-1AM
SITRANS RD100, loop powered display - see Chapter 7	7ML5741-.....-
SITRANS RD150, remote digital display for 4 ... 20 mA and HART devices - see Chapter 7	7ML5742-.....-
SITRANS RD200, universal input display with Modbus conversion - see Chapter 7	7ML5740-.....-
SITRANS RD300, dual line display with totalizer and linearization curve and Modbus conversion - see Chapter 7	7ML5744-.....-
For applicable back up point level switch - see point level measurement section	

## Selection and ordering data (continued)

		Article No.											
<b>SITRANS LR200 Radar level transmitter with horn</b>		7ML5425- ● ● ● ● ● - ● ● ● ● ●											
<b>Continuous, non-contact, 20 m (66 ft) range, for liquids and slurries.</b>													
Click on the Article No. for the online configuration in the PIA Life Cycle Portal.													
<b>Antenna material (uses antenna adapter)</b>													
316L stainless steel with PTFE cone emitter		0											
316L stainless steel with PTFE cone emitter and purge connection with 1/8" NPT inlet <sup>1)</sup>		1											
<b>Process connection (refer to LR200 Pressure/Temperature curves)</b>													
Flanges (316L stainless steel)													
DN 50 PN 16 EN 1092-1 Type A flat faced <sup>1)</sup>		A		A									
DN 80 PN 16 EN 1092-1 Type A flat faced		B		A									
DN 100 PN 16 EN 1092-1 Type A flat faced		C		A									
DN 150 PN 16 EN 1092-1 Type A flat faced		D		A									
DN 200 PN 16 EN 1092-1 Type A flat faced		E		A									
DN 80 PN 10/16 DIN EN 1092-1 Type B1 raised face <sup>2)</sup>		B		F									
DN 100 PN 10/16 DIN EN 1092-1 Type B1 raised face <sup>3)</sup>		C		F									
DN 150 PN 10/16 DIN EN 1092-1 Type B1 raised face <sup>3)</sup>		D		F									
DN 200 PN 16 DIN EN 1092-1 Type B1 raised face <sup>3)</sup>		E		F									
2" ASME 150 lb, flat faced <sup>1)</sup>		F		B									
3" ASME 150 lb, flat faced		G		B									
4" ASME 150 lb, flat faced		H		B									
6" ASME 150 lb, flat faced		J		B									
8" ASME 150 lb, flat faced		K		B									
DN 50 PN 40, flat faced <sup>3)</sup>		A		C									
DN 80 PN 40, flat faced <sup>3)</sup>		B		C									
DN 100 PN 40, flat faced <sup>3)</sup>		C		C									
DN 80 PN 25/40 DIN EN 1092-1 Type B1 raised face <sup>3)</sup>		C		G									
DN 100 PN 25/40 DIN EN 1092-1 Type B1 raised face <sup>3)</sup>		D		G									
DN 150 PN 25/40 DIN EN 1092-1 Type B1 raised face <sup>3)</sup>		E		G									
2" ASME 300 lb, flat faced <sup>1)3)</sup>		F		D									
3" ASME 300 lb, flat faced <sup>3)</sup>		G		D									
4" ASME 300 lb, flat faced <sup>3)</sup>		H		D									
JIS DN 50 10K <sup>1)</sup>		A		E									
JIS DN 80 10K		B		E									
JIS DN 100 10K		C		E									
JIS DN 150 10K		D		E									
JIS DN 200 10K		E		E									
(Note: Flange bolting patterns and facings dimensionally correspond to the applicable ASME B16.5, or EN 1092-1, or JIS B 2220 standard.)													
<b>Communication/Output</b>													
PROFIBUS PA								1					
4 ... 20 mA, HART, start-up at < 3.6 mA								2					
<b>Process seal/gasket</b>													
FKM (-40 ... +200 °C)								0					
<b>Enclosure/Cable inlet</b>													
Aluminum, Epoxy painted													
2 x 1/2" NPT										2			
2 x M20 x 1.5										3			
<b>Horn size/Waveguide options</b>													
80 mm (3 inch) horn <sup>3)</sup>										B			
100 mm (4 inch) horn <sup>4)</sup>										C			
150 mm (6 inch) horn										D			
200 mm (8 inch) horn										E			
100 mm (4 inch) horn with 100 mm (4 inch) waveguide extension <sup>4)</sup>										F			
100 mm (4 inch) horn with 150 mm (6 inch) waveguide extension <sup>4)</sup>										G			
100 mm (4 inch) horn with 200 mm (8 inch) waveguide extension <sup>4)</sup>										H			
100 mm (4 inch) horn with 250 mm (10 inch) waveguide extension <sup>4)</sup>										J			
150 mm (6 inch) horn with 100 mm (4 inch) waveguide extension										K			
150 mm (6 inch) horn with 150 mm (6 inch) waveguide extension										L			
150 mm (6 inch) horn with 200 mm (8 inch) waveguide extension										M			

## SITRANS LR200

## Selection and ordering data (continued)

SITRANS LR200 Radar level transmitter with horn Continuous, non-contact, 20 m (66 ft) range, for liquids and slurries.		Article No. 7ML5425- ● ● ● ● ● - ● ● ● ● ●												
150 mm (6 inch) horn with 250 mm (10 inch) waveguide extension												N		
200 mm (8 inch) horn with 100 mm (4 inch) waveguide extension												P		
200 mm (8 inch) horn with 150 mm (6 inch) waveguide extension												Q		
200 mm (8 inch) horn with 200 mm (8 inch) waveguide extension												R		
200 mm (8 inch) horn with 250 mm (10 inch) waveguide extension												S		
<b>Approvals</b>														
Ordinary Locations/General Purpose (Non-Ex), CE, UKCA, RED, RCM													A	
Ordinary Locations/General Purpose (Non-Ex), CSA, FM, IC, FCC													B	
Intrinsically Safe, CSA Class I, II, Div. 1, Groups A, B, C, D, E, F, G, Industry Canada													C	
Intrinsically Safe, FM Class I, II, Div. 1, Groups A, B, C, D, E, F, G, FCC													D	
Intrinsically Safe; ATEX II 1G Ex ia IIC T4 Ga; UKEX II 1G Ex ia IIC T4 Ga; IECEX Ex ia IIC T4 Ga; INMETRO Ex ia IIC T4 Ga, IP67/IP68; EAC Ex 0Ex ia IIC T4 Ga X; CE, UKCA, RED, RCM, EAC													E	
Non incandive, FM Class I, Div. 2, Groups A, B, C, D, FCC <sup>4)</sup>													F	
Increased Safety: ATEX II 1/2G Ex eb mb ia IIC T4 Ga/Gb; UKEX II 1/2G Ex eb mb ia IIC T4 Ga/Gb; CE, UKCA, RED, RCM, EAC <sup>2)3)</sup>													G	
Flameproof: ATEX II 1/2G Ex db mb ia IIC T4 Ga/Gb; UKEX II 1/2G Ex db mb ia IIC T4 Ga/Gb; CE, UKCA, RED, RCM, EAC <sup>3)</sup>													H	
Explosion Proof, CSA/FM Class I, II, III, Groups A, B, C, D, E, F, G, Industry Canada, FCC <sup>5)7)</sup>													J	
<b>Pressure rating</b>														
Rating per Pressure/Temperature curves in manual														0
0.5 bar g (7.25 psi g) maximum														1

- 1) Available with pressure rating option 1 only.
- 2) Available with Antenna Material options 0 and 1 only.
- 3) For stillpipe applications only.
- 4) Available with enclosure option 2 only.
- 5) Available with enclosure option 3 only.
- 6) Available with communication option 2 only.
- 7) Available with Communication/Output option 2 only.

Selection and Ordering data	Order code
<b>Further designs</b>	
Please add "-Z" to Article No. and specify Order code(s).	
Stainless steel tag [69 x 50 mm (2.71 x 1.97 inch)]: Measuring-point number/identification (max. 27 characters); specify in plain text	<b>Y15</b>
Manufacturer's test certificate: M to DIN 55350, Part 18 and to ISO 9000	<b>C11</b>
Material inspection Certificate Type 3.1 per EN 10204	<b>C12</b>
Namur NE43 compliant, device preset to failsafe < 3.6 mA <sup>1)</sup>	<b>N07</b>

Accessories	Article No.
<b>Operating Instructions</b>	
All literature is available to download for free, in a range of languages, at <a href="http://www.siemens.com/processinstrumentation/documentation">http://www.siemens.com/processinstrumentation/documentation</a>	
<b>Accessories</b>	<b>Article No.</b>
Handheld programmer, Intrinsically safe, EEx ia	<b>7ML1930-1BK</b>
HART modem with USB interface	<b>7MF4997-1DB</b>



Accessories	Article No.
One metallic cable gland M20 x 1.5, rated -40 ... +80 °C (-40 ... +176 °F), HART <sup>2)</sup>	<b>7ML1930-1AP</b>
One metallic cable gland M20 x 1.5, rated -40 ... +80 °C (-40 ... +176 °F), PROFIBUS PA <sup>3)</sup>	<b>7ML1930-1AQ</b>
One general purpose polymeric cable gland M20 x 1.5, rated -40 ... +80 °C (-40 ... +176 °F)	<b>7ML1930-1AM</b>
SITRANS RD100, loop powered display - see Chapter 7	<b>7ML5741-.....</b>
SITRANS RD150, remote digital display for 4 ... 20 mA and HART devices - see Chapter 7	<b>7ML5742-.....</b>
SITRANS RD200, universal input display with Modbus conversion - see Chapter 7	<b>7ML5740-.....</b>
SITRANS RD300, dual line display with totalizer and linearization curve and Modbus conversion - see Chapter 7	<b>7ML5744-.....</b>
For applicable back up point level switch - see point level measurement section	





- 1) Available with communication option 2 only.
- 2) Product shipped with plastic cable gland, rated to -20 °C. If -40 °C rating required, then metallic cable gland is recommended.
- 3) Available with enclosure option 2 only.



## Selection and ordering data (continued)



## SITRANS LR200 Specials

	Order No.
SITRANS LR200 PROFIBUS PA aluminum enclosure kit with electronics and covers (7ML5423, 7ML5425), calibrated for use with standard rod antenna	
SITRANS LR200 aluminum enclosure with board stack, LUI display, 5.8 GHz, M20 cable inlet, approval option E, with PROFIBUS PA communication, no process connection.	A5E01483420
SITRANS LR200 aluminum enclosure with board stack, LUI display, 5.8 GHz, M20 cable inlet, approval option A, with PROFIBUS PA communication, no process connection.	A5E01483440
SITRANS LR200 aluminum enclosure with board stack, LUI display, 5.8 GHz, M20 cable inlet, approval option C, with PROFIBUS PA communication, no process connection.	A5E01483456
SITRANS LR200 aluminum enclosure with board stack, LUI display, 6.3 GHz, NPT cable inlet, approval option C, with PROFIBUS PA communication, no process connection.	A5E01483547
SITRANS LR200 aluminum enclosure with board stack, LUI display, 5.8 GHz, NPT cable inlet, approval option E, with PROFIBUS PA communication, no process connection.	A5E01483559
SITRANS LR200 HART aluminum enclosure kit with electronics and covers (7ML5423, 7ML5425), calibrated for use with standard rod antenna	
SITRANS LR200 aluminum enclosure with board stack, LUI display, 5.8 GHz, M20 cable inlet, approval option A, with HART communication start-up at < 3.6 mA, no process connection.	A5E02956419
SITRANS LR200 aluminum enclosure with board stack, LUI display, 5.8 GHz, M20 cable inlet, approval option E, with HART communication start-up at < 3.6 mA, no process connection.	A5E02956420
SITRANS LR200 aluminum enclosure with board stack, LUI display, 5.8 GHz, M20 cable inlet, approval option G, with HART communication start-up at < 3.6 mA, no process connection.	A5E02956421
SITRANS LR200 aluminum enclosure with board stack, LUI display, 5.8 GHz, M20 cable inlet, approval option H, with HART communication start-up at < 3.6 mA, no process connection.	A5E02956422
SITRANS LR200 aluminum enclosure with board stack, LUI display, 5.8 GHz, NPT cable inlet, approval option A, with HART communication start-up at < 3.6 mA, no process connection.	A5E03617085
SITRANS LR200 aluminum enclosure with board stack, LUI display, 6.3 GHz, NPT cable inlet, approval option B, with HART communication start-up at < 3.6 mA, no process connection.	A5E03617086
SITRANS LR200 aluminum enclosure with board stack, LUI display, 5.8 GHz, NPT cable inlet, approval option C, with HART communication start-up at < 3.6 mA, no process connection.	A5E03617087
SITRANS LR200 aluminum enclosure with board stack, LUI display, 6.3 GHz, NPT cable inlet, approval option E, with HART communication start-up at < 3.6 mA, no process connection.	A5E03617088
Sun shield for SITRANS LR200 enclosure, stainless steel	A5E39142556
	

	Order No.
SITRANS LR200 horn antenna kits with mounting screws (no emitter supplied)	
80 mm (3 inch) horn antenna kit	PBD-25500K02A
100 mm (4 inch) horn antenna kit	PBD-25500K03A
150 mm (6 inch) horn antenna kit	PBD-25500K05A
SITRANS LR200 Extension Kits for Horn Antenna with mounting screw	
100 mm (4 inch) extension kit for horn antenna	PBD-25501K0100A
150 mm (6 inch) extension kit for horn antenna	PBD-25501K0150A
200 mm (8 inch) extension kit for horn antenna	PBD-25501K0200A
250 mm (10 inch) extension kit for horn antenna	PBD-25501K0250A
500 mm (20 inch) extension kit for horn antenna	PBD-25501K0500A
1 000 mm (40 inch) extension kit for horn antenna	PBD-25501K1000A
SITRANS LR200 flanged rod antenna kit with 316L stainless steel flat faced flanges	
Flanged PTFE rod antenna kit, 2" ASME, 150 lb. See drawing 51003 on <a href="http://www.siemens.com/radar">http://www.siemens.com/radar</a> . <sup>1,4)</sup>	PBD-51003K020AAAA
Flanged PTFE rod antenna kit, DN 50 PN16. See drawing 51003 on <a href="http://www.siemens.com/radar">http://www.siemens.com/radar</a> . <sup>1,4)</sup>	PBD-51003K050AJAA
Flanged PTFE rod antenna kit, JIS 10K DN 50. See drawing 51003 on <a href="http://www.siemens.com/radar">http://www.siemens.com/radar</a> . <sup>1,4)</sup>	PBD-51003K050AOAA
SITRANS LR200 PTFE rod antenna kit with 316L stainless steel 1½" pipe thread process connection	
PTFE rod antenna kit, R 1½" (BSPT), EN 10226 316L stainless steel process connection, FKM O-ring. See drawing 51004 on <a href="http://www.siemens.com/radar">http://www.siemens.com/radar</a> . <sup>4)</sup>	PBD-51004K2AAA
PTFE rod antenna kit, 1½" G 316L stainless steel process connection, FKM O-ring. See drawing 51004 on <a href="http://www.siemens.com/radar">http://www.siemens.com/radar</a> . <sup>4)</sup>	PBD-51004K3AAA
SITRANS LR200 PTFE rod antenna kit with 316L stainless steel 2" pipe thread process connection	
PTFE rod antenna kit, 2" NPT 316L stainless steel process connection, FKM O-ring. See drawing 51005 on <a href="http://www.siemens.com/radar">http://www.siemens.com/radar</a> . <sup>4)</sup>	PBD-51005K1AAA
PTFE rod antenna kit, R 2" (BSPT), EN 10226 316L stainless steel process connection, FKM O-ring. See drawing 51005 on <a href="http://www.siemens.com/radar">http://www.siemens.com/radar</a> . <sup>4)</sup>	PBD-51005K2AAA
PTFE rod antenna kit, 2" G 316L stainless steel process connection, FKM O-ring. See drawing 51005 on <a href="http://www.siemens.com/radar">http://www.siemens.com/radar</a> . <sup>4)</sup>	PBD-51005K3AAA

## SITRANS LR200

## Selection and ordering data (continued)

	Order No.
SITRANS LR200 PTFE rod antenna kit (100 mm shield) with 316L stainless steel 2" pipe thread process connection	
PTFE rod antenna shielded kit, 2" NPT 316L stainless steel process connection, FKM O-ring, 100 mm 316L stainless steel shield. See drawing 51002 on <a href="http://www.siemens.com/radar">http://www.siemens.com/radar</a> . <sup>3,4)</sup>	PBD-51002K0100AAA
PTFE rod antenna shielded kit, R 2" (BSPT), EN 10226 316L stainless steel process connection, FKM O-ring, 100 mm 316L stainless steel shield. See drawing 51002 on <a href="http://www.siemens.com/radar">http://www.siemens.com/radar</a> . <sup>3,4)</sup>	PBD-51002K0100BAA
PTFE rod antenna shielded kit, 2" G 316L stainless steel process connection, FKM O-ring, 100 mm 316L stainless steel shield. See drawing 51002 on <a href="http://www.siemens.com/radar">http://www.siemens.com/radar</a> . <sup>3,4)</sup>	PBD-51002K0100CAA
SITRANS LR200 horn antenna kit with 316L stainless steel flat faced flange, with PTFE emitter (without waveguide)	
Horn antenna kit, 2" ASME 316L stainless steel flange 3" horn, PTFE emitter <sup>1,4)</sup>	PBD-51006K020AAAA
Horn antenna kit, 2" ASME 316L stainless steel flange 4" horn, PTFE emitter <sup>1,2)</sup>	PBD-51006K020AABA
Horn antenna kit, 2" ASME 316L stainless steel flange 6" horn, PTFE emitter <sup>1,2)</sup>	PBD-51006K020AACA
Horn antenna kit, 2" ASME 316L stainless steel flange 8" horn, PTFE emitter <sup>1,2)</sup>	PBD-51006K020AADA
Horn antenna kit, DN 50 PN 16 316L stainless steel flange 80 mm horn, PTFE emitter <sup>1,2)</sup>	PBD-51006K050AJAA
Horn antenna kit, DN 50 PN 16 316L stainless steel flange 100 mm horn, PTFE emitter <sup>1,2)</sup>	PBD-51006K050AJBA
Horn antenna kit, DN 50 PN 16 316L stainless steel flange 150 mm horn, PTFE emitter <sup>1,2)</sup>	PBD-51006K050AJCA
Horn antenna kit, DN 50 PN 16 316L stainless steel flange 200 mm horn, PTFE emitter <sup>1,2)</sup>	PBD-51006K050AJDA

	Order No.
SITRANS LR200 PTFE flanged rod antenna kit with 316L stainless steel shield and 316L stainless steel flat faced flange	
PTFE shielded rod antenna kit, flanged, 3" ASME 150 lb 316L stainless steel flange, 100 mm 316L stainless steel shield. <sup>1,4)</sup>	PBD-51014K0100AAA
PTFE shielded rod antenna kit, flanged, DN 80 PN 16 316L stainless steel flange, 100 mm 316L stainless steel shield. <sup>1,4)</sup>	PBD-51014K0100EJA
PTFE shielded rod antenna kit, flanged, 3" ASME 150 lb 316L stainless steel flange, 150 mm 316L stainless steel shield. <sup>1,4)</sup>	PBD-51014K0150AAA
PTFE shielded rod antenna kit, flanged, DN 80 PN 16 316L stainless steel flange, 150 mm 316L stainless steel shield. <sup>1,4)</sup>	PBD-51014K0150EJA
PTFE shielded rod antenna kit, flanged, 3" ASME 150 lb 316L stainless steel flange, 200 mm 316L stainless steel shield. <sup>1,4)</sup>	PBD-51014K0200AAA
PTFE shielded rod antenna kit, flanged, DN 80 PN 16 316L stainless steel flange, 200 mm 316L stainless steel shield. <sup>1,4)</sup>	PBD-51014K0200EJA
PTFE shielded rod antenna kit, flanged, 3" ASME 150 lb 316L stainless steel flange, 250 mm 316L stainless steel shield. <sup>1,4)</sup>	PBD-51014K0250AAA
PTFE shielded rod antenna kit, flanged, DN 80 PN 16 316L stainless steel flange, 250 mm 316L stainless steel shield. <sup>1,4)</sup>	PBD-51014K0250EJA
<b>PTFE paste</b> Kit, PTFE paste, Tube, 250 mL	PBD-51036065
<b>Cable gland</b> One metallic cable gland M20 x 1.5, rated -40 ... +80 °C (-40 ... +176 °F), HART	7ML1930-1AP
One metallic cable gland M20 x 1.5, rated -40 ... +80 °C (-40 ... +176 °F), PROFIBUS PA	7ML1930-1AQ

- 1) Available in flange sizes including ASME, DIN and JIS. Please consult a local sales person for details.
- 2) Available with no pressure rating. Please consult a local sales person for details.
- 3) Available in other shield lengths. Please consult a local sales person for details.
- 4) Available with Pressure rating. Please consult a local sales person for details.

Customers interested in a custom designed device should consult a local sales person. For more information, please visit [http://www.automation.siemens.com/aspa\\_app](http://www.automation.siemens.com/aspa_app).

## Technical specifications

SITRANS LR200	
<b>Mode of operation</b>	
Measuring principle	Radar level measurement
Frequency	C-band, approx. 6 GHz
Measuring range	0.3 ... 20 m (1.0 ... 65 ft)
<b>Output</b>	
Analog output	4 ... 20 mA
Accuracy	± 0.02 mA
Span	Proportional or inversely proportional
Communications	HART Optional: PROFIBUS PA (Profile 3.0, Class B)
Fail-safe	Programmable as high, low or hold (Loss of Echo)
<b>Performance (according to reference conditions IEC60770-1)</b>	
From end of antenna to 600 mm	40 mm (1.57 inch)
Remainder of range	10 mm (0.4 inch) or 0.1 % of span (whichever is greater)
<b>Rated operating conditions</b>	
Installation conditions	
• Location	Indoor/outdoor
Ambient conditions (enclosure)	
• Ambient temperature	-40 ... +80 °C (-40 ... +176 °F)
• Storage temperature	-40 ... +80 °C (-40 ... +176 °F)
• Installation category	I
• Pollution degree	4
<b>Medium conditions</b>	
Dielectric constant $\epsilon_r$	$\epsilon_r > 1.6$ (for $\epsilon_r < 3$ , use stillpipe)
Vessel temperature and pressure	Varies with connection type; see Pressure/Temperature curves for more information
<b>Design</b>	
Enclosure	
• Material	Aluminum, polyester powder coated
• Cable inlet	2 x M20 x 1.5 or 2 x 1/2" NPT
Degree of protection	Type 4X/NEMA 4X, Type 6/ NEMA 6, IP67, IP68
Weight	< 2.82 kg (6.21 lb) (polypropylene rod antenna)
Display (local)	Multi-segment alphanumeric liquid crystal with bar graph (representing level) available in four languages
Antenna	
• Material	Polypropylene rod, hermetically sealed construction, optional PTFE
• Dimensions	Standard 100 mm (4 inch) shield for maximum 100 mm (4 inch) nozzle, or optional 250 mm (10 inch) long shield
• Optional rods and horn	Refer to SITRANS LR200 Antennas for optional rods and horns
Process connections	
• Process connection	1 1/2" NPT [(Taper), ASME B1.20.1] R 1 1/2" [(BSPT), EN 10226], or G 1 1/2" [(BSPP), EN ISO 228-1] (polypropylene rod antenna)
• Flange connection	Refer to SITRANS LR200 Antennas for more connections
<b>Power supply</b>	
4 ... 20 mA/HART	
• General Purpose, Non-incendive, Intrinsically Safe	Nominal 24 V DC (max. 30 V DC) with max. 550 $\Omega$

## Technical specifications (continued)

SITRANS LR200	
• Flame proof, Increased safety, Explosion proof	Nominal 24 V DC (max. 30 V DC) with max. 250 $\Omega$
PROFIBUS PA	<ul style="list-style-type: none"> <li>• 10.5 mA</li> <li>• Per IEC 61158-2</li> </ul>
<b>Certificates and approvals</b>	
General	
Marine	CSA <sub>US/IC</sub> , CE, FM, RCM <ul style="list-style-type: none"> <li>• Lloyd's Register of Shipping</li> <li>• ABS Type Approval</li> </ul>
Radio	
Hazardous	FCC, Industry Canada, and European (RED), RCM
• Intrinsically Safe (Brazil)	INMETRO Ex ia IIC T4 Ga
• Explosion Proof (Canada/USA)	CSA/FM, Class I, Div. 1, Groups A, B, C, D; Class II, Div. 1, Groups E, F, G; Class III, T4
• Intrinsically Safe (Canada/USA)	CSA/FM, Class I, Div. 1, Groups A, B, C, D; Class II, Div. 1, Groups E, F, G; Class III, T4
• Non-incendive (USA)	FM, Class I, Div. 2, Groups A, B, C, D, T5
• Flame Proof/Increased Safety (China)	NEPSI Ex d mb ia IIC T4/ Ex e mb ia IIC T4
• Flame Proof (Europe)	ATEX II 1/2 G Ex d mb ia IIC T4 Ga/Gb
• Flame Proof (UK)	UKEX II 1/2 G Ex d mb ia IIC T4 Ga/Gb
• Increased Safety (Europe)	ATEX II 1/2 G Ex e mb ia IIC T4 Ga/Gb
• Increased Safety (UK)	UKEX II 1/2 G Ex e mb ia IIC T4 Ga/Gb
• Intrinsically Safe (Europe)	ATEX II 1G Ex ia IIC T4 Ga
• Intrinsically Safe (UK)	UKEX II 1G Ex ia IIC T4 Ga
• Intrinsically Safe (International)	IECEx Ex ia IIC T4
• Intrinsically Safe (Russia/Kazakhstan)	EAC Ex ia
<b>Programming</b>	
Intrinsically Safe Siemens handheld programmer	Infrared receiver
• Approvals for handheld programmer	IS model: ATEX II 1 GD Ex ia op is IIC T4 Ga, ATEX II 1 GD Ex ia op is IIIC T135°C Da, Ta = -20°C to +50°C; UKEX II 1 GD Ex ia op is IIC T4 Ga, UKEX II 1 GD Ex ia op is IIIC T135°C Da, Ta = -20°C to +50°C; CSA/FM Class I, II, III, Div. 1, Groups A, B, C, D, E, G, T6, Ta = 50°C; IECEx SIR 09.0073
Handheld communicator	HART communicator 375
PC	<ul style="list-style-type: none"> <li>• SIMATIC PDM</li> <li>• AMS</li> <li>• SITRANS DTM (for connecting to FDT such as PACTware or Fieldcare)</li> </ul>
Display (local)	Multi-segment alphanumeric liquid crystal with bar graph (representing level) available in four languages

## SITRANS LR200

## Characteristic curves

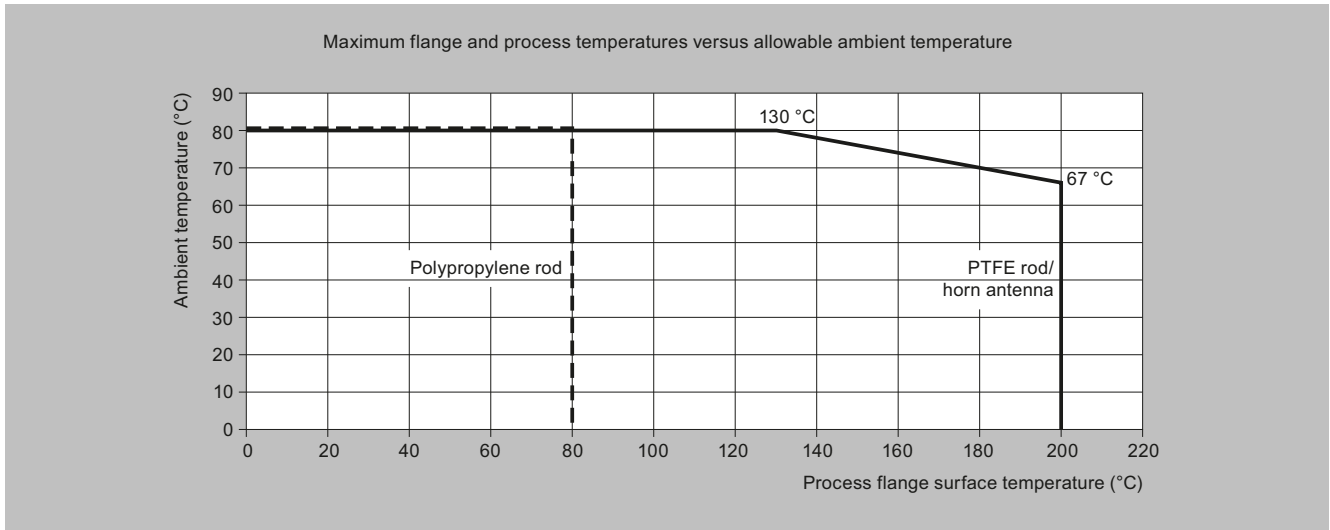

SITRANS LR200 ambient/process flange surface temperature curve

## Characteristic curves (continued)

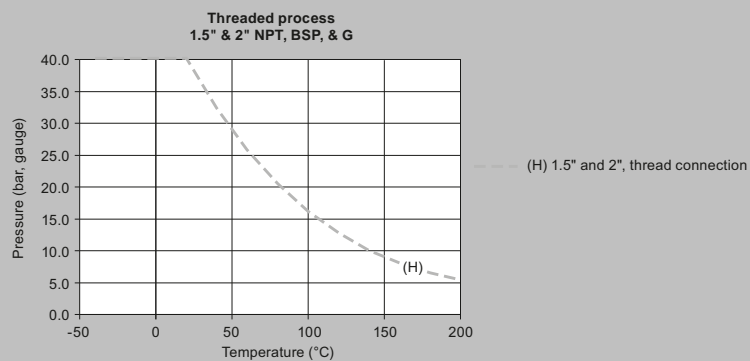
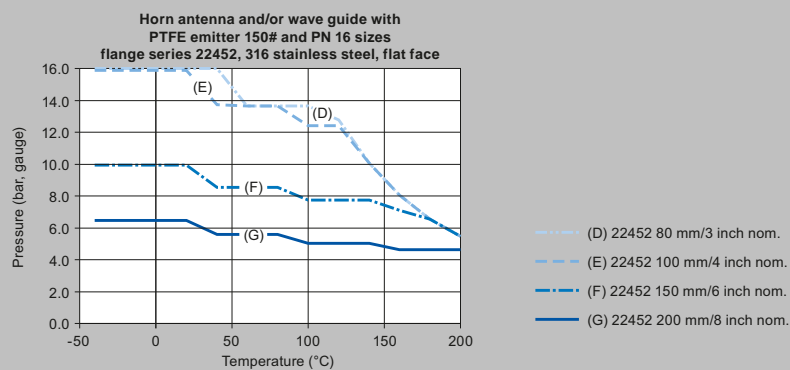
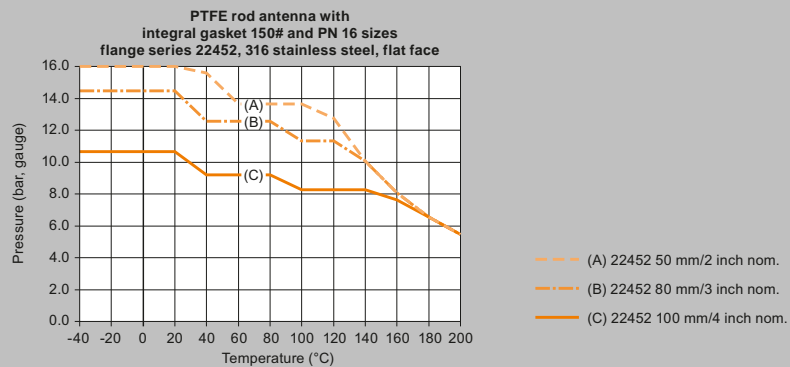

SITRANS LR200 process pressure/temperature derating curves

SITRANS LR200

Dimensional drawings

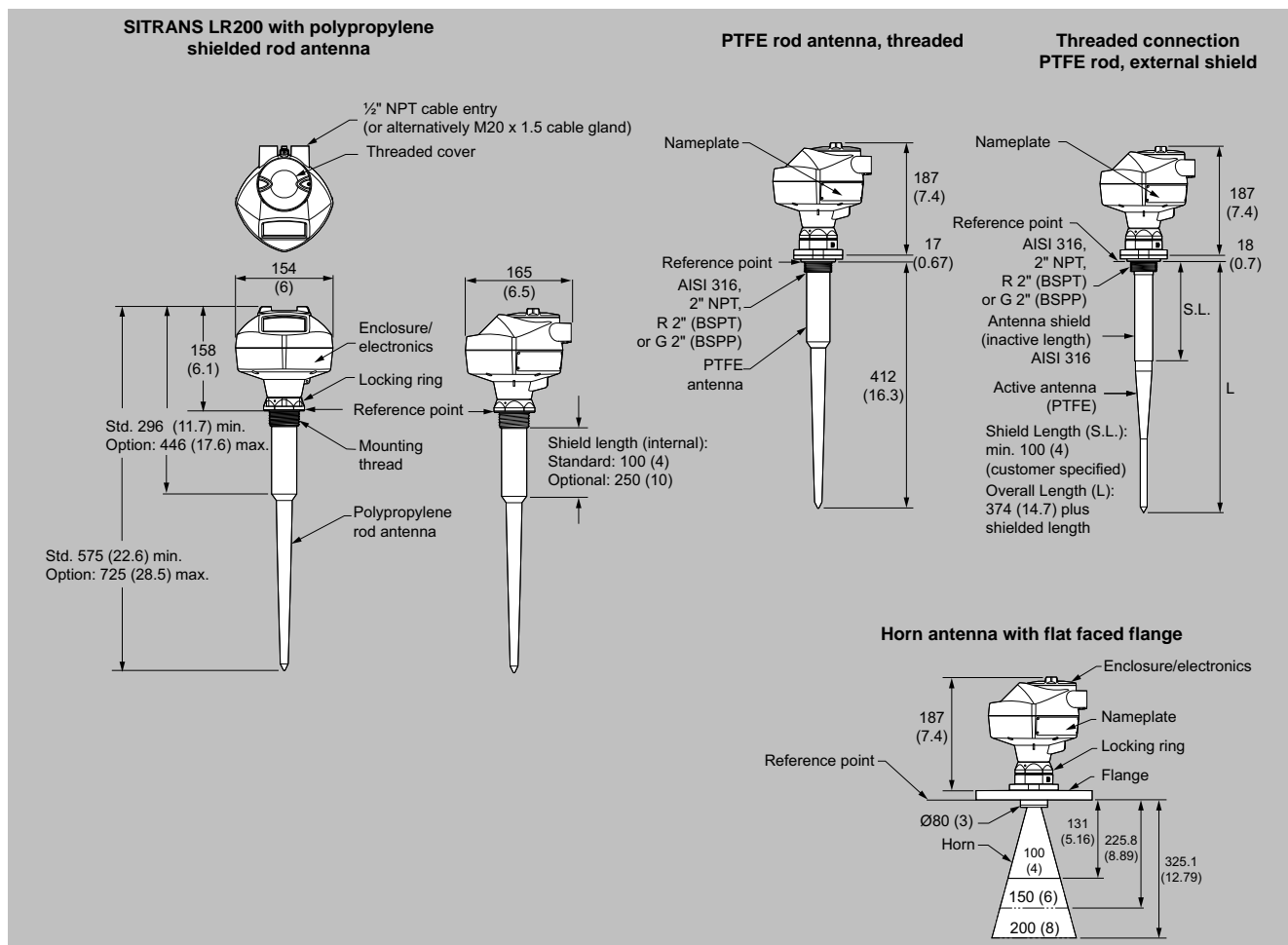

SITRANS LR200, dimensions in mm (inch)

## Circuit diagrams

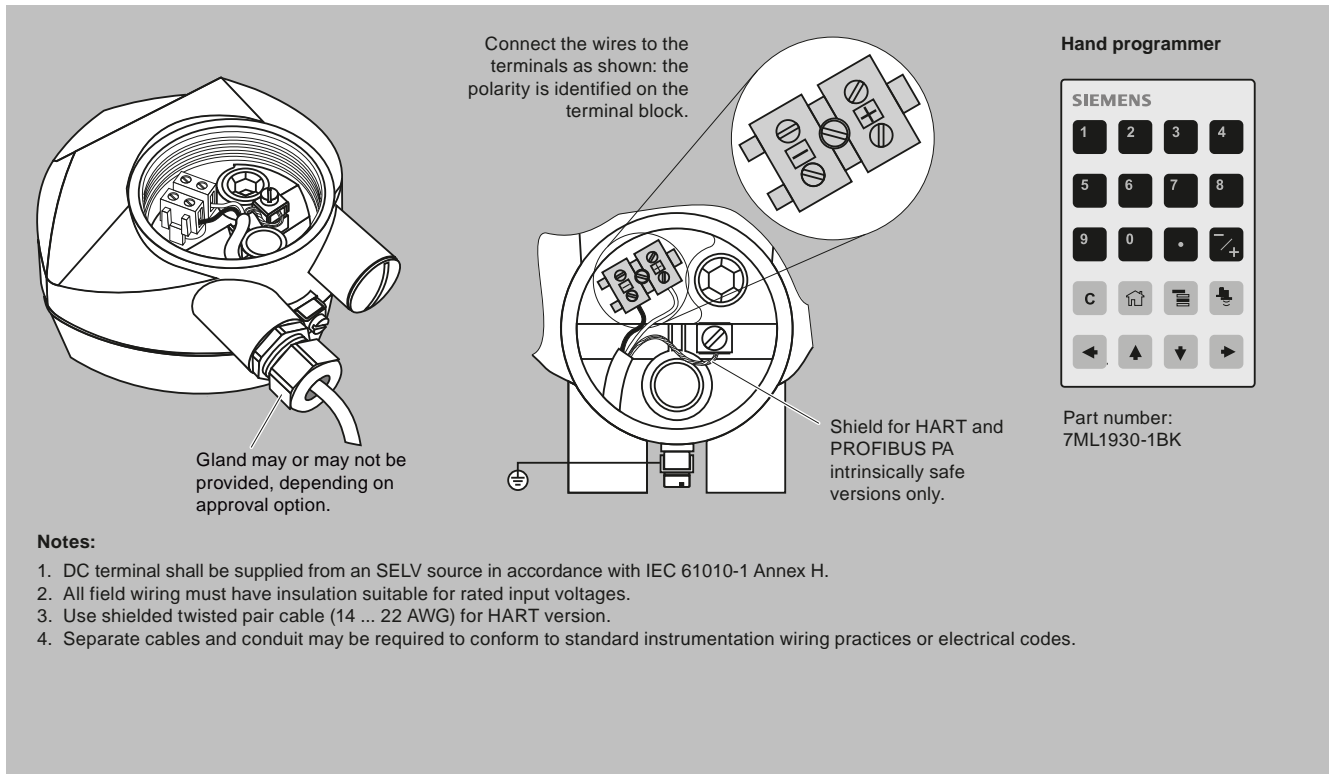

SITRANS LR200 connections